

# Production Booklet

for

## SANKEY SPA



2800 Richter Ave. Suite C, Oroville, CA 95965 • **voice:** (530)534-9910

• **email:** [sales@tiledspas.com](mailto:sales@tiledspas.com)

• **website:** [www.tiledspas.com](http://www.tiledspas.com)

# RECOMMENDED MAINTENANCE

## *Please Note:*

These are only recommended guidelines to care for a Nespa all tiled spa. Local codes may require additional procedures, therefore consult with a pool professional that is LA county Health Department certified for more information on local codes and requirements.

## *SPA SURFACE*

Your spa tile is acid resistant and frost-proof. The Tile does not absorb germs or algae. Tile does not stain and is very easy to clean. Color does not fade or lose its luster. All grouts are epoxy based and are extremely durable. To remove scum line use soft nylon brush and small amounts of biodegradable soaps. Do not use abrasive brushes or chemicals.

## *MAINTENANCE*

---

### **A. CHEMICALS:**

- 1) It is important to maintain a chlorine residual of 2 PPM in the spa. That residual can be provided by chlorine or bromine.
- 2) It is recommended to use Bromine or dichlor (granular) forms of chlorine. If bromine Tabs are used we suggest floating or inline dispenser.
- 3) Never use acid to lower Ph in the tile spa.
- 4) Never use trichlor chlorine (1" or 3") tablets in the Nespa spas.
- 5) Never place tablets in skimmer basket.

### **B. DRAINING THE SPA:**

- 1) It is recommended to drain the spa at least once every 2 months depending on bath load and water clarity.
- 2) The spa should be drained through valve exiting re-circulation pump in the spa equipment room or sump pump.
- 3) Note: Use caution to drain spa in the winter months or rainy season when water table is at its highest. It is possible for the spa to float due to hydraulic pressure from surrounding water table. We advise that you consult with your local spa specialist prior to draining the spa.

### **C. SPA EQUIPMENT:**

- 1) Clean filter cartridge at least once every month, or when needed; i.e., if water clarity does not improve after several days.
- 2) Keep area free and clear from leaves and debris build-up.
- 3) Keep area free and clear from flooding.

### **D. SPA LIGHT:**

- 1) Spa light has to be on GFCI circuit. It is controlled at spa side with ON/OFF.

### **E. TILE SERVICING:**

- 1) Contact manufacture when servicing tile or grout. @ (530) 534-9910



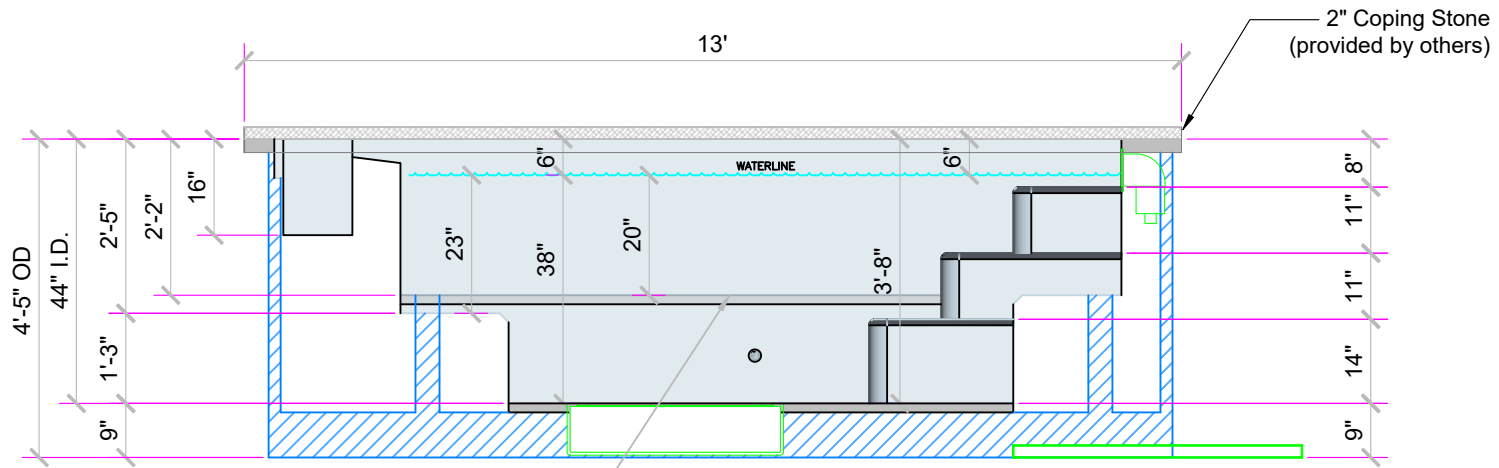

Bullnose Tile Typical

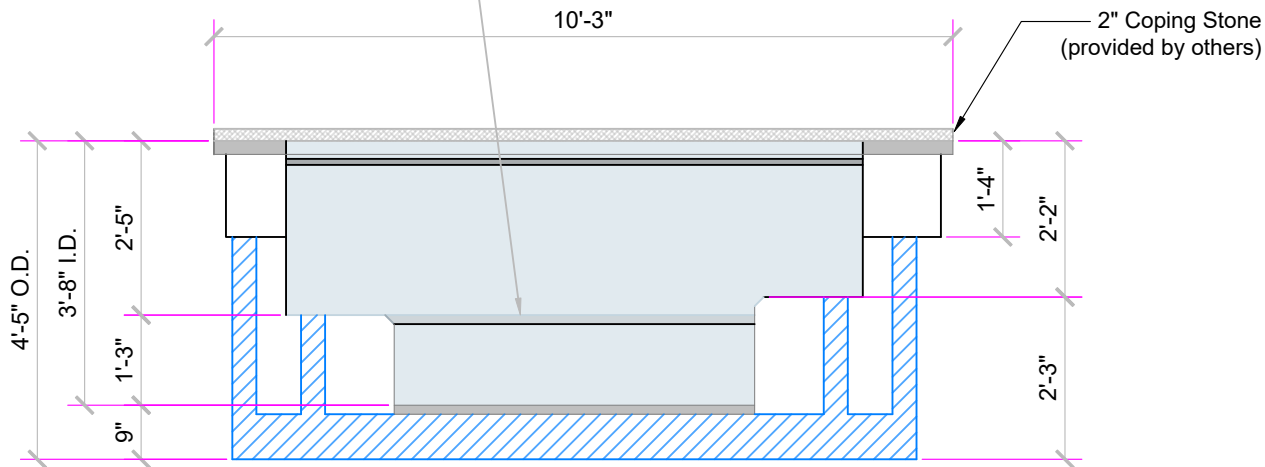

**NESPA ENTERPRISES INC.**  
 2800 Richter Ave. Ste. C Oroville, CA 95966  
 Office: (530) 534-9910  
 E-Mail: [jim@tiledspas.com](mailto:jim@tiledspas.com) Web  
 Site: [www.tiledspas.com](http://www.tiledspas.com)



**Approved**

DWG-SIZE **A** DWG **SANKEY**

LAYOUT **Sections**

SCALE:  $3/8" = 1'$

SHEET: **2 OF 6**

DATE: **12/7/2020** JOB#

**0**



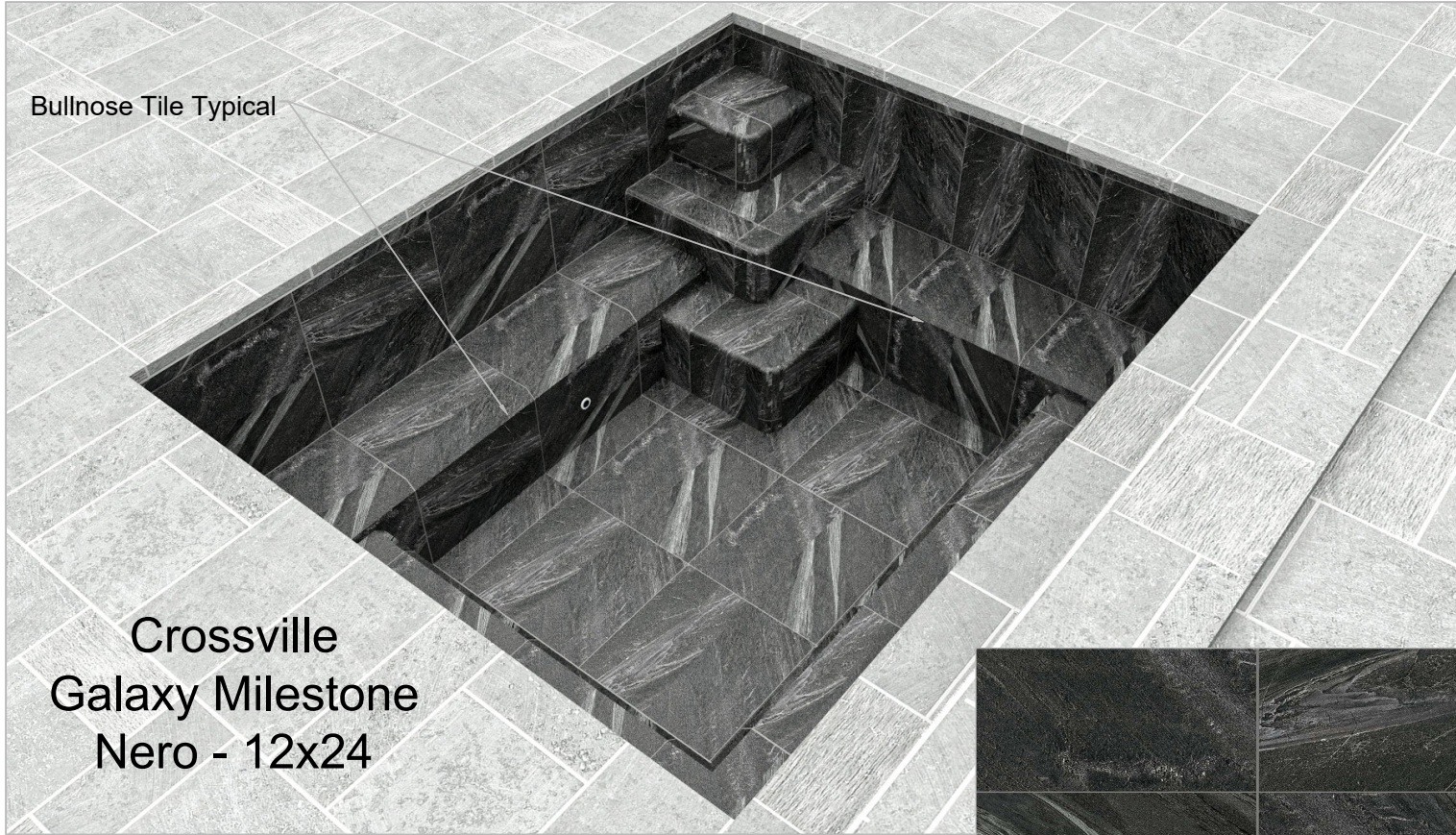

Bullnose Tile Typical

Crossville  
Galaxy Milestone  
Nero - 12x24

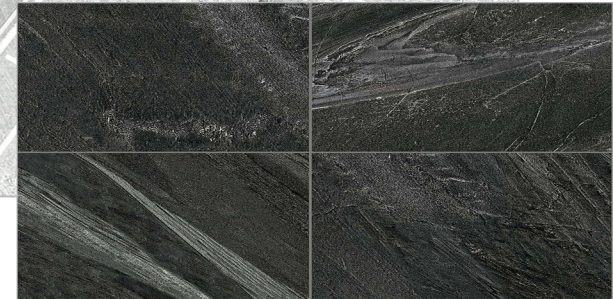

Approval Signature

NESPA ENTERPRISES INC.

2800 Richter Ave. Ste. C Oroville, CA 95966

Office: (530) 534-9910

E-Mail: [jim@tiledspas.com](mailto:jim@tiledspas.com) Web

Site: [www.tiledspas.com](http://www.tiledspas.com)



Approved

DWG-SIZE **A**

DWG **SANKEY**

LAYOUT







Tile SCALE: N/A

SHEET: 3 OF 6

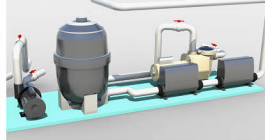
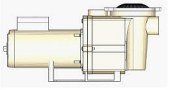
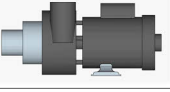
DATE: 1/21/2021

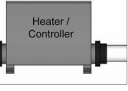
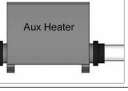
JOB#

0

<b>NESPA B203165AOPAC Spa Power Pack</b>			<b>Description:</b> Nespa <b>B203165-AOP-AC</b> Spa Power Pack is a spa support equipment assembly. Composed of Filter pump, Booster Jet Pump, Cartridge Filter, 5.5 kW heater, (2) AUX 5.5KW heater, DEL AOP 25 Ozone, AutoCover, LED Multi color light and Touch screen control panel.  <b>MODEL:</b> NESPA B203165-AOP-AC <b>SERIAL:</b> NSC-B203165AOPAC-2020 <b>VOLTS:</b> 240V / 60Hz / 4 Wire <b>AMPS:</b> 43A  <b>Power Requirements:</b> 240VAC, 60HZ, 43A, Class A GFCI-protected service (Circuit Breaker Rating = 60A max.) 4 Wires (Hot-Line 1, Hot-Line 2, Neutral, Ground)
QTY			
(A)	1	<b>FILTER PUMP -</b>	 PENTAIR - SUPERFLO MODEL # - 340036 RATED - .5 HP VOLTAGE - 230V Full Load AMPS: 5.4 A
(B)	2	<b>BOOSTER PUMP</b>	 WATERWAY EXECUTIVE - 5HP MODEL # - 3712021-13 RATED - 5HP VOLTAGE - 230 Full Load AMPS: 13.0 A
(C)	1	<b>FILTER</b>	 STA-RITE - System 2 - Modular Media Filters - PLM Series MODEL # - PLM 150 Filter Area - 150 Sq Ft Flow Rated GPM - 58-150 Sq Ft Turnover Capacity in 1 HR - 4,000 Gallons
(D)	1	<b>HEATER / CONTROLLER</b>	 BALBOA Heater - MODEL # - BP501G1 - PART # - 56487-04 240V - 60Hz - 20amps
(E)	2	<b>AUX HEATER</b>	 BALBOA Heater Slave - MODEL # - RH-Slaves-CA-5.5K PART # 55986 240V - 60Hz - 20amps.  <b>Fuse 30 amp GFCI</b>
(F)	1	<b>OZONE</b>	 DEL AOP 25 Max Flow Rate = 20GPM VOLTAGE = 110/240VAC - 50/60 HZ - 0.3 Amps UL cUL Certified Part # SEC-50
	1	<b>LIGHT</b>	 Jandy - Pro Series - HydroCool - Nicheless LED 12W - 12V - 50' - RGBW P - SERIES LIGHT Part # JLU4C12W50P
	1	<b>TOPSIDE CONTROL</b>	 BALBOA Topside Control Model # TP600
	1	<b>AUTO COVER</b>	 COVERSTAR - Auto-cover Model # CS300HD 120V = 60Hz - 5 amps  <b>Fuse 15 amp GFCI</b>

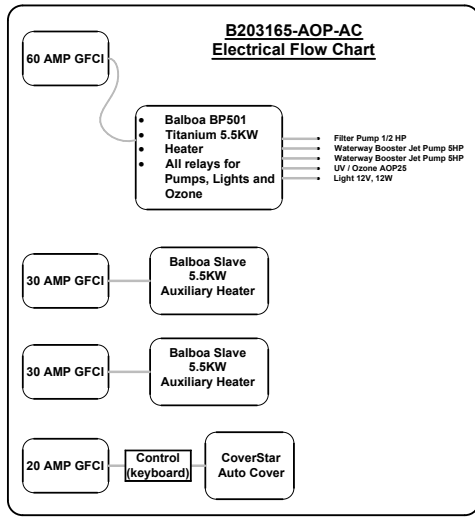
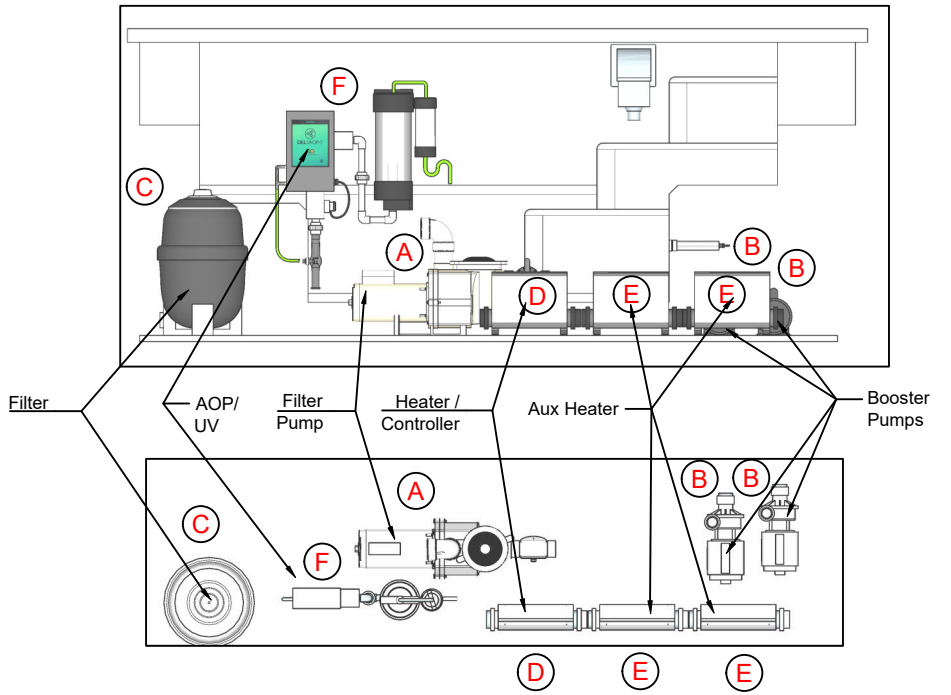

9/21/2020  
 Nespa Titled Spa  
 Revolution Control Pack  
 Transforming the Control of Hot Tubs

**GFCI**  
 It is required by code to install a Ground Fault Circuit Interrupter (GFCI) in the supply power for a spa. This device will trip the heater if there is an unsafe electrical condition caused by a manufacturing component or user the equipment subject to ground.  
 Note: Current the control system only be a circuit protected by a Class A GFCI circuit at least 5' (1.5M) from the inside walls of the spa/hot tub and in the sight from the equipment compartment.  
 Refer to NEC (National Electrical Code), 2008 Edition, Article 680 for more information.

**WARNING: FAILURE TO PROVIDE A DEDICATED CIRCUIT FOR YOUR SPA ELECTRICAL INSTALLATION CAN CAUSE EQUIPMENT DAMAGE AND INVALIDATE YOUR WARRANTY.**  
 Your spa electrical installation must be accomplished by a qualified and licensed electrician in accordance with the National Electrical Code (NEC) Article 680, Canadian Electrical Code, and with any local codes effective at the time of installation.  
 All installations must be made according to the electrical installation label inside the control box. Follow the instructions from the label if they are different than instructions listed in this manual. If your electrician is not absolutely sure how to correctly connect your system, call your dealer. Do not guess. Any mistake may result in an invalidation of your equipment warranty.  
 The GFCI is a mandatory electrical safety device required for all portable spas and hot tubs as specified in the National Electrical Code Article 680-42. The GFCI for your particular installation may be installed at the electrical service panel, a separate sub-panel or built into your spa's equipment system. Equipment systems with a built in GFCI meeting the code requirements will be marked on the top of the control panel with an identification label. Your spa equipment requires a dedicated circuit. No other appliances or lights can be on this circuit. Refer to equipment data label for power supply requirements of your spa equipment. Use copper conductors only.  
 The ground must be equal to or larger than the largest ungrounded conductor.  
 NOTE: Due to the spa electrical installation requirement of some models, it may be required to RFLTE the incoming electrical service to accommodate the GFCI Circuit Breaker Installation. Contact your electrician if you need additional information on this topic or others related to your spa electrical installation.

Power Requirements for Nespa spa:  
**BASIC PACKAGE:**  
 1- 60 amp 230v, 4wire, GFCI circuit for primary control pack and 5.5 kw heater.  
**BOOSTER HEATER Optional:**  
 1- 30 amp 230v, 3 wire, GFCI circuit for secondary heater 5.5 kw heater.



Approved

DWG-SIZE A DWG SANKEY

LAYOUT Remote EQ SCALE: 3/8" = 1'

SHEET: 4 OF 6 DATE: 1/21/2021 JOB#

0

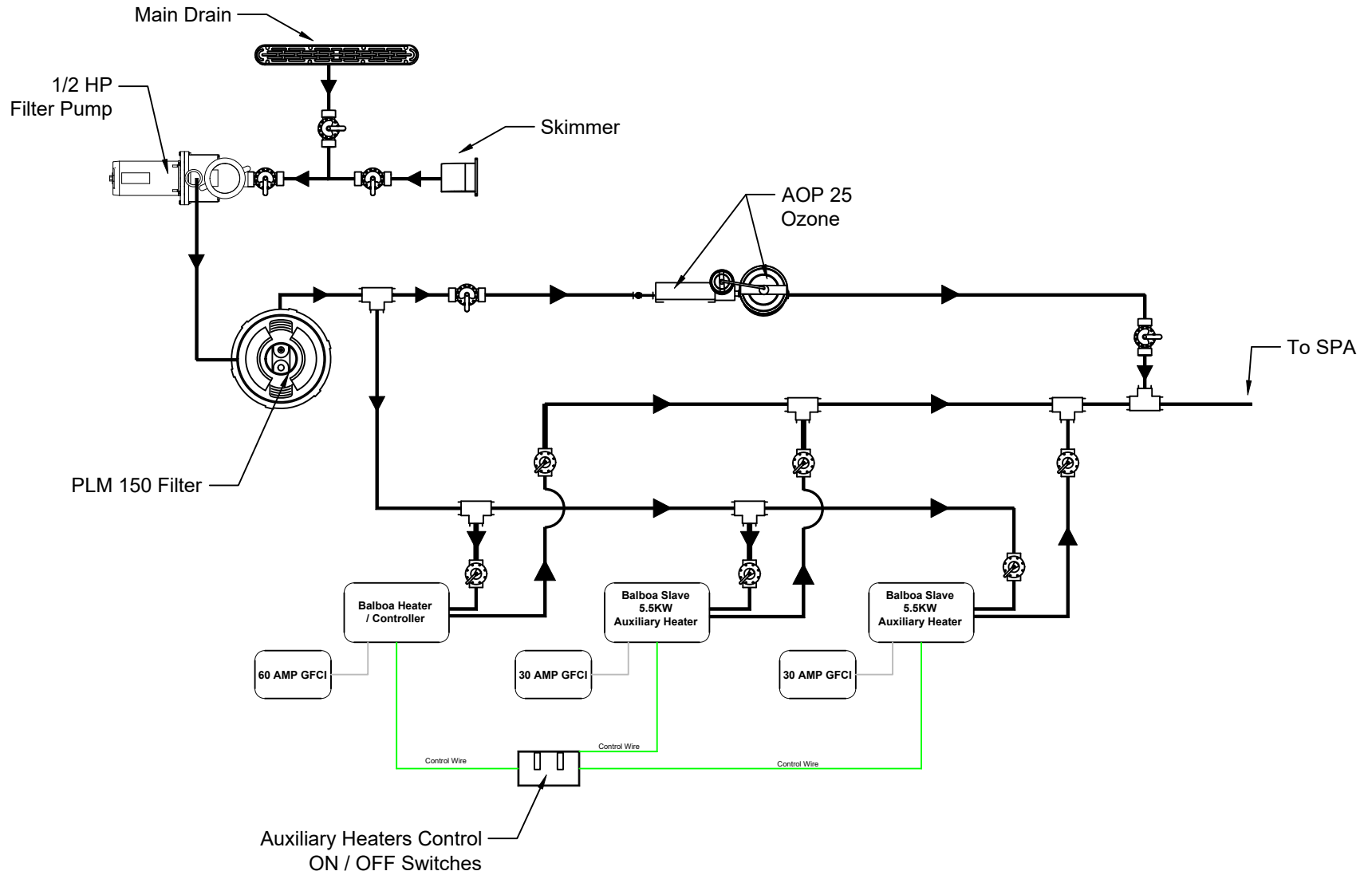

Approved

DWG-SIZE **A** DWG SANKEY

LAYOUT EQ Schematic

SCALE: N/A

SHEET: 5 OF 6

DATE: 1/21/2021 JOB#

0

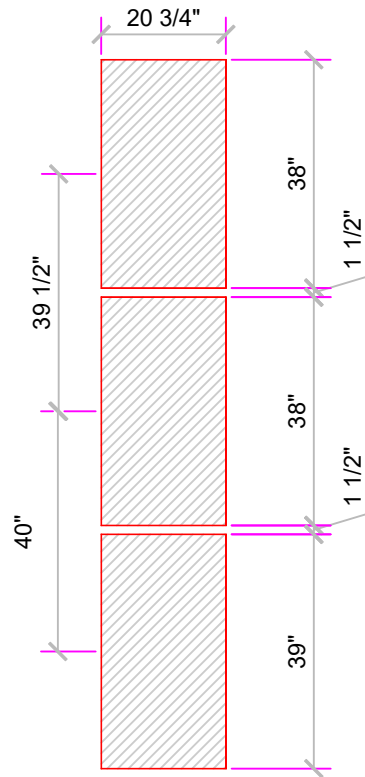
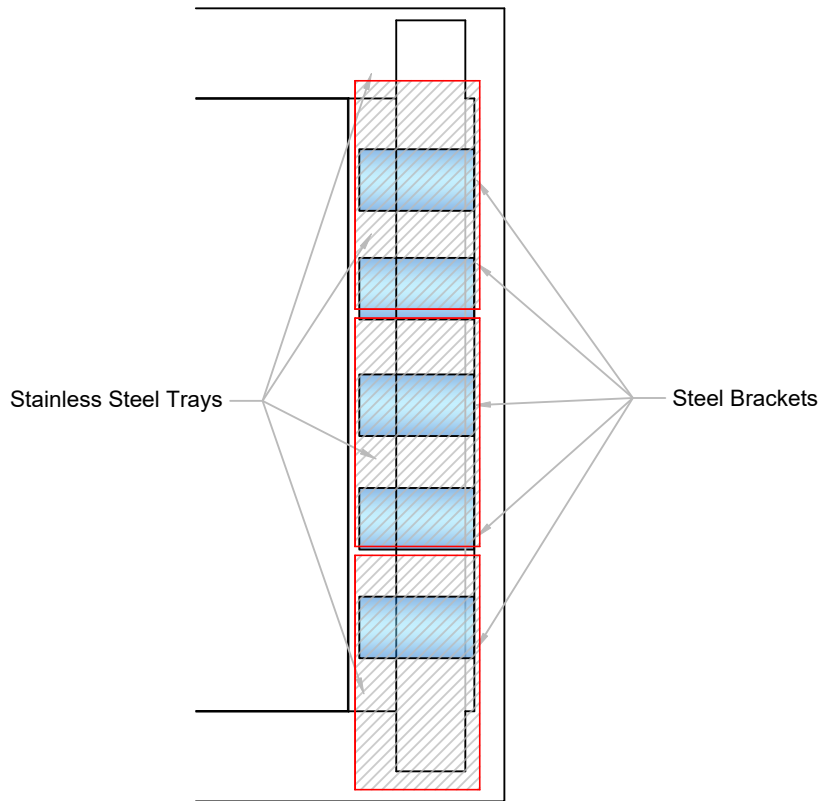

**Stainless Steel Trays**

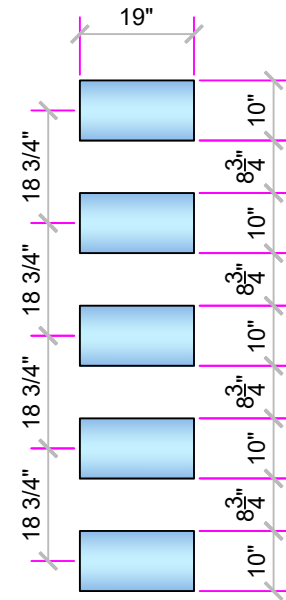

**Steel Brackets**

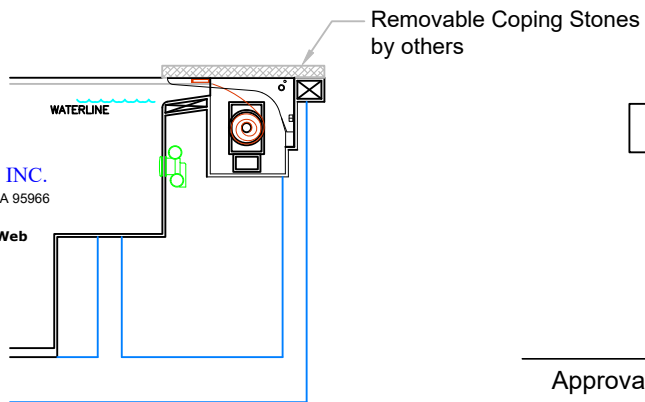

Cover Color: Charcoal Grey

Approval Signature

**CoverStar Colors**



**NESPA ENTERPRISES INC.**  
 2800 Richter Ave. Ste. C Oroville, CA 95966  
 Office: (530) 534-9910  
 E-Mail: [jim@tiledspas.com](mailto:jim@tiledspas.com) Web  
 Site: [www.tiledspas.com](http://www.tiledspas.com)



**Approved**

DWG-SIZE **A** DWG **SANKEY**

LAYOUT **Coverbox**

SCALE: 3/8" = 1'

SHEET: 6 OF 6

DATE: 1/21/2021

JOB#

**0**



# STANDARD NESPA IN-GROUND INSTALLATION *INSTRUCTIONS* **SET-UP AND EXCAVATION**

**Prerequisites:** Before installing your Nespa spa. You may be required to acquire a permit from your local State, County, and City building dept and or Health department. (Commercial jobs need Health Dept. Approval). Your spa installation must comply with the most current codes. (**Uniform Swimming Pool, Spas & Hot Tub Code 2006 (USPC 2006)**).

**Spa drawings:** Request from Nespa a current spa specific construction detail, plan and section, spa plumbing detail.

**Delivery Access:** Clearly determine the method of getting the spa to jobsite and into the hole. This may require the use of a crane, forklift, hoist, backhoe and/or manpower etc.

- 1) The following instructions are general guidelines and may not apply to your specific jobsite conditions. When excavating for your spa remember to provide for plumbing and light connection clearances. In order to determine how to excavate for your spa or swim spa, measure spas outside dimension (O.D.) and add minimum 3" to all sides. This 3" clearance is to accommodate jet and suction plumbing. This 3" clearance can change or be reduced upon request. Note: skimmer location, this area may have to be larger than 3", if commercial 22".
- 2) **Freeze Climates-** If the spa is placed into a vault (typical of freeze climates) a standard 18" or more of clearance minimum from spa perimeter should be provided. This dead air space is for possible future access to spa plumbing in case of a freeze. Area drain is mandatory. **Ask your local installer** for his experienced opinion. Do not hesitate to call us because we want to be sure that your installation progresses as smoothly as possible. If you have questions call us. (888) 479-4677.
- 2) **Hole depth** is determined by spa's outside height dimension. This height may vary depending if spa has skids or no skids. The spa lip may be finished or non-finished. How is the perimeter deck elevation transitioning to the spa? Focus on the finish surrounding deck elevations, thickness of the finish material on spa upper horizontal lip, equal to lip or under the spa lip. This material can be tile, stone, concrete or brick.
- 3) **Preplumb** the spa before it goes into the hole. If there are needs for electrical, bonding or control conduits run them as well before dropping in hole. Connect bond wire to niche would be best.
- 4) **Spa should sit on level 3 ½" thick reinforced concrete pad. Sweep debris off pad prior to dropping in hole.**
- 5) **Install spa** into the hole on top of concrete pad. Use the Eye bolts provided for crane, forklift etc. rigging. Do not hold onto pipes. Use caution with suction and jet plumbing when lowering into hole. **DO NOT STRESS FITTINGS!** Fill Spa with water and check for leaks prior to backfill.

- 6) **Check site reference** points for proper spa positioning (i.e., squaring to house, garage, etc.).
- 7) **Shim to level spa.** Shim with non-compression able material. Re square to house, or ref. point.
- 8) **Dry pack** with cement the gaps that have been created when shimming spa level.
- 9) **Connect pipes to tees** if spa is preplumb. Installers properly support your new plumbing from stressing spas preplumb fittings. After electrical conduit and bond wire is connected to light niche, water test spa before back filling with sand.  
**NOTE: All Nespa products are water tested prior to leaving factory.**

### **ELECTRICAL:**

- 1) All electrical connections to spa or equipment should comply with the most recent national electrical code (NEC), state and local codes.
- 2) Connect electrical conduit to light niche. This work should be done or reviewed by a licensed electrician.
- 3) To install spa light you will need to include inside the PVC conduit to the light niche a solid #8 coated copper wire. (If you are use brass conduit, internal bond wire is not required.) This bond wire should be pulled with the light cord at the same time. This bond wire needs to be attached to the internal bonding lug of the light niche. An approved encapsulate should be applied to bond wire connection in niche.
- 4) An external #8 copper wire shall be connected to the external bonding lug on the rear of the light niche. This copper wire can then be used for additional bonding requirements (i.e., handrails or any other metallic object within 5' of the spa.

### **PLUMBING:**

- 1) **When plumbing a Nespa it is important to properly size the plumbing. We highly recommend that you follow the pump manufacturer's pipe sizing requirements and Uniform Swimming Pool, Spas & Hot Tub Code 2006 ( USPC 2006). This code book is available at [www.IAPMO.org](http://www.IAPMO.org) or (909) 472 4100.**
- 2) The jet air venturi should be a Hartford loop design adjacent to spa shell and air entry point can be located next to spa or remotely at equipment.
- 3) Fill spa with water and test the system for leaks PRIOR to backfilling with sand.

### **SAND BACK FILL:**

- 1) **With water in spa, back-fill around spa perimeter with dry plaster sand and wet wash with hydraulic attachment to hose. Let set for one hour and hydraulic dry again. Be sure water level in spa is at the highest level. Any questions please call us. ( 888) 479-4677.**
- 2) **If spa is free standing on elevated deck or a structure, it is important to fill spa with water and load area prior to installing coping or perimeter decking. If spa is installed in a vault situation a area drain is needed.**

## **NESPA ENTERPRISES, Inc. LIMITED WARRANTY**

**This LIMITED WARRANTY covering NESPA products is extended to the ORIGINAL PURCHASER-USER BY NESPA ENTERPRISES Inc.(NESPA), 2800 Richter Ave. Unit C California 95966.**

**NESPA products are thoroughly inspected and tested prior to factory shipment. NESPA warrants to the ORIGINAL PURCHASER-USER that NESPA Spas and Swim Spas will be free of defect in workmanship, accessories and parts, provided said accessories and parts were manufactured by NESPA. NESPA, under this LIMITED WARRANTY, warrants only that its Spas and Swim Spas shall be structurally sound, shall retain their shape, and shall retain water for the warranty period. NESPA warrants the adhesion of tile to fiberglass for a period of three (3) years and structural soundness for ten (10) years. NESPA warrants epoxy grout adhesion for a period of three years. If any such defects appear and are reported within the warranty period, NESPA shall repair or replace such defective parts without charge if an inspection proves the claim.**

**The provisions of the LIMITED WARRANTY shall not apply to tile cracked, split, chipped or damaged after the product has left the factory, nor damage to tile caused by freezing nor to damage, defect, malfunction or failure to conform with the above warranty provisions where the damage, defect, malfunction or failure to conform was caused during shipment or by distributor or by unreasonable use by ORIGINAL PURCHASER-USER including improper water balance and improper sand pack or support.**

**This LIMITED WARRANTY shall not apply to any plumbing, equipment, or installation of spas and Swim Spas and shall not apply to any alterations made to or upon NESPA products except alterations made by NESPA employees or NESPA authorized representatives.**

**This LIMITED WARRANTY is expressly in lieu of all other warranties expressed or implied including the warranties of merchantability and fitness for use and all other obligations or liabilities on NESPA'S part, and NESPA neither assumes nor authorizes any other person to assume for NESPA any other liability in connection with the sale of this NESPA product. This LIMITED WARRANTY shall not apply to this NESPA product or any part thereof which has been subject to accident, negligence, alteration, abuse or misuse. NESPA makes no warranty whatsoever with respect to accessories or parts not manufactured by NESPA.**

**The term "ORIGINAL PURCHASER-USER" as used in this LIMITED WARRANTY shall be deemed to mean that person for whom the NESPA product is originally installed.**

**The LIMITED WARRANTY provided herein and the obligations and liabilities of NESPA hereunder are exclusive and are in lieu of, and buyer and original PURCHASE-USER hereby waive all other remedies, warranties, guarantees or liabilities, expressed or implied, arising by law or otherwise (including without limitation and obligations of NESPA with respect to fitness, merchantability, and consequential damages) or whether or not occasioned by NESPA'S negligence.**

**This LIMITED WARRANTY shall not be extended, altered or varied except by a written instrument signed by NESPA and original PURCHASER-USER.**